

- 1. Easylock (bl + ro = blind)
- 2. Easylock + LED Beleuchtung

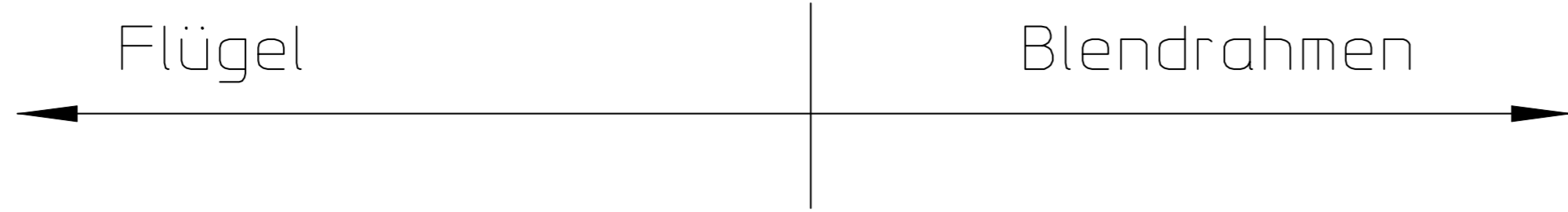

Einzelheit A  
Verdrahtung Steckverbindung im Rahmen

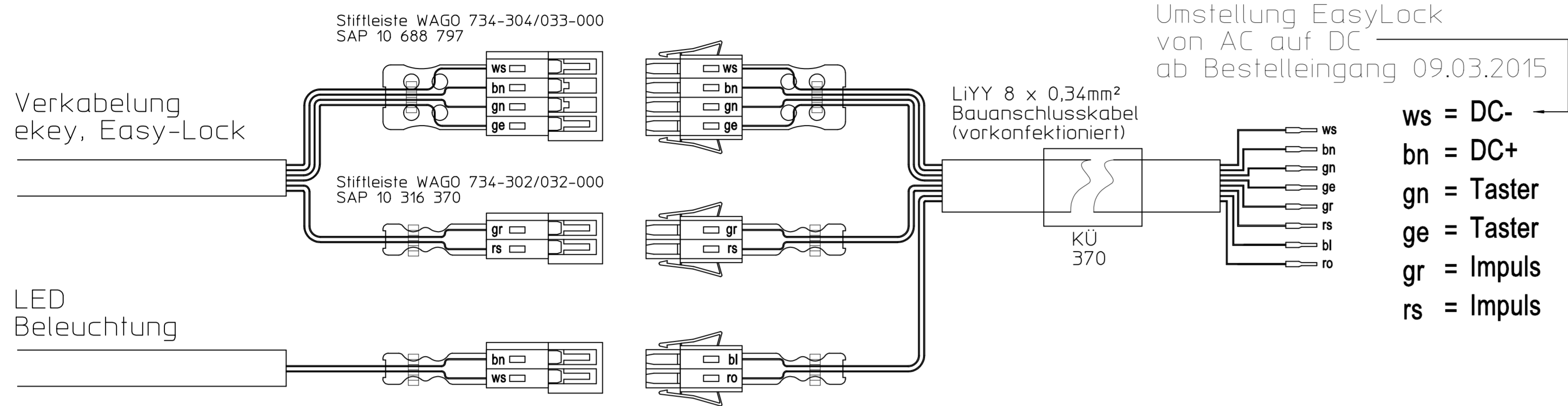

Umstellung EasyLock von AC auf DC ab Bestelleingang 09.03.2015

Kombination Autolock + LED

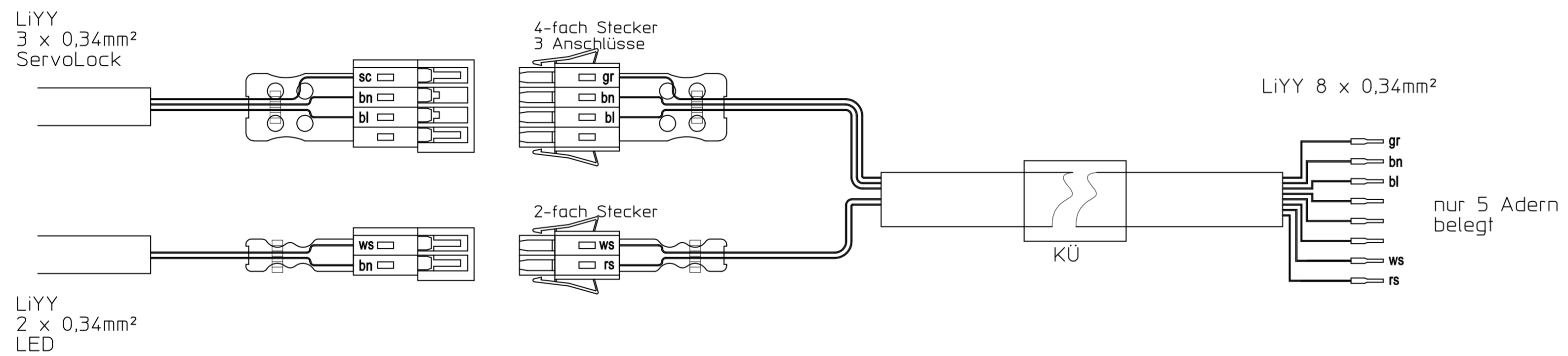
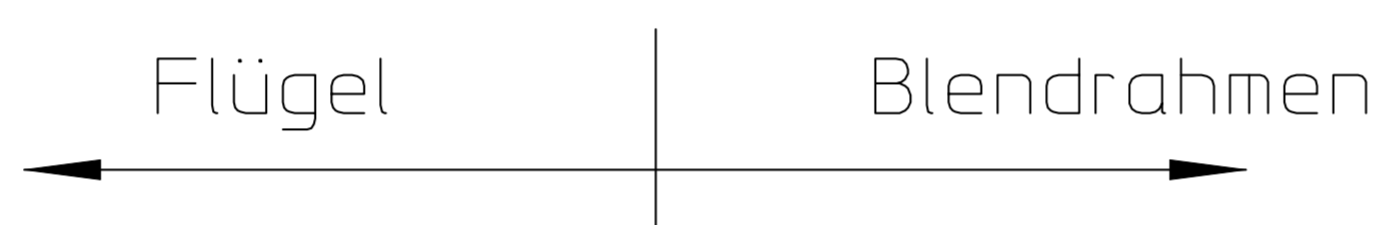

Flügel | Blendrahmen

Autolock

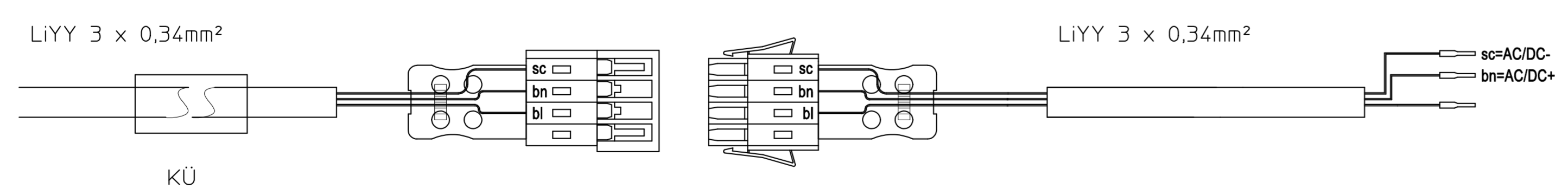

Flügel | Blendrahmen

LED-Beleuchtung

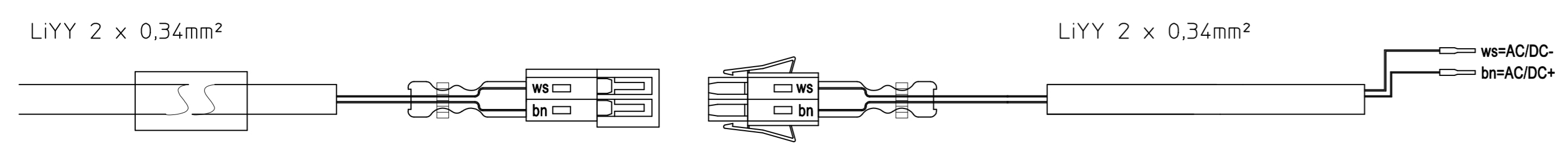

Schematische Darstellung der Kabelverlegung

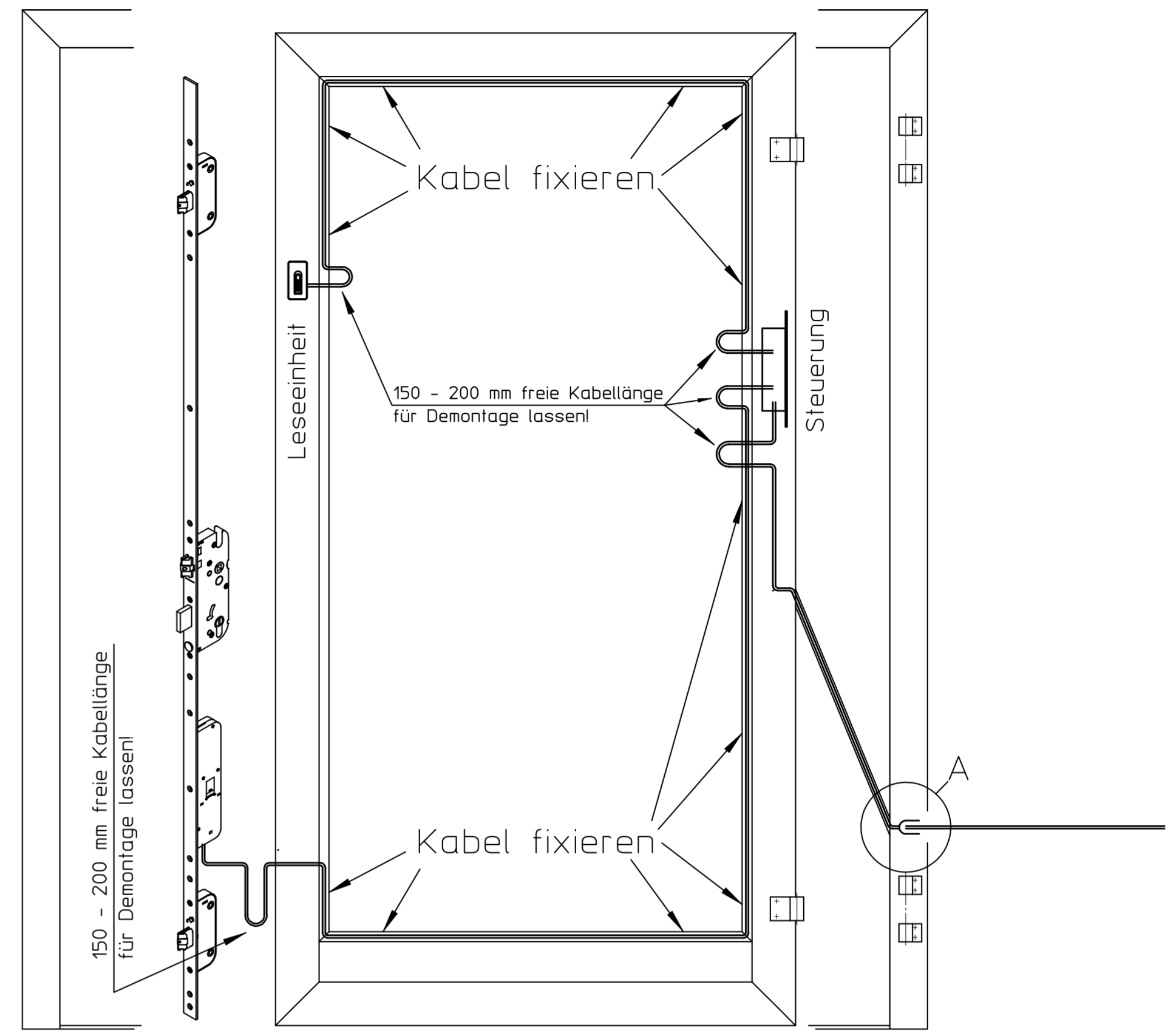

- Allgemeine Farblegende**
- ws = weiß
  - bn = braun
  - gn = grün
  - ge = gelb
  - gr = grau
  - rs = rosa
  - bl = blau
  - ro = rot
  - sc = schwarz

Freimaßtoleranz		Oberfläche		Maßstab 1:1	Gewicht
Bearb. 11.06.15 16:08 ARusch		Name		Werkstoff	
Gepr. 15.06.15 08:54 BGiesel		Benenn.		Kabelbelegung	
Freig. 15.06.15 08:54 BGiesel		Funktion		Easy-Lock, Auto-Lock, LED	
Status freigegeben		System		ATRIS/SEDOR/VILLA fb/AVIDA	
C E-Polung / Darstellung 11.06.15 16:08 Adin Ruscho		Zeichnungs-Nr.		Index	Blatt
A Schemadarstellung 15.02.15 07:37 Ingrid Escher		UAZ03160		C	1
Index	Anderung	Datum	Name	Urspr.	Ers.für
					Ers.durch